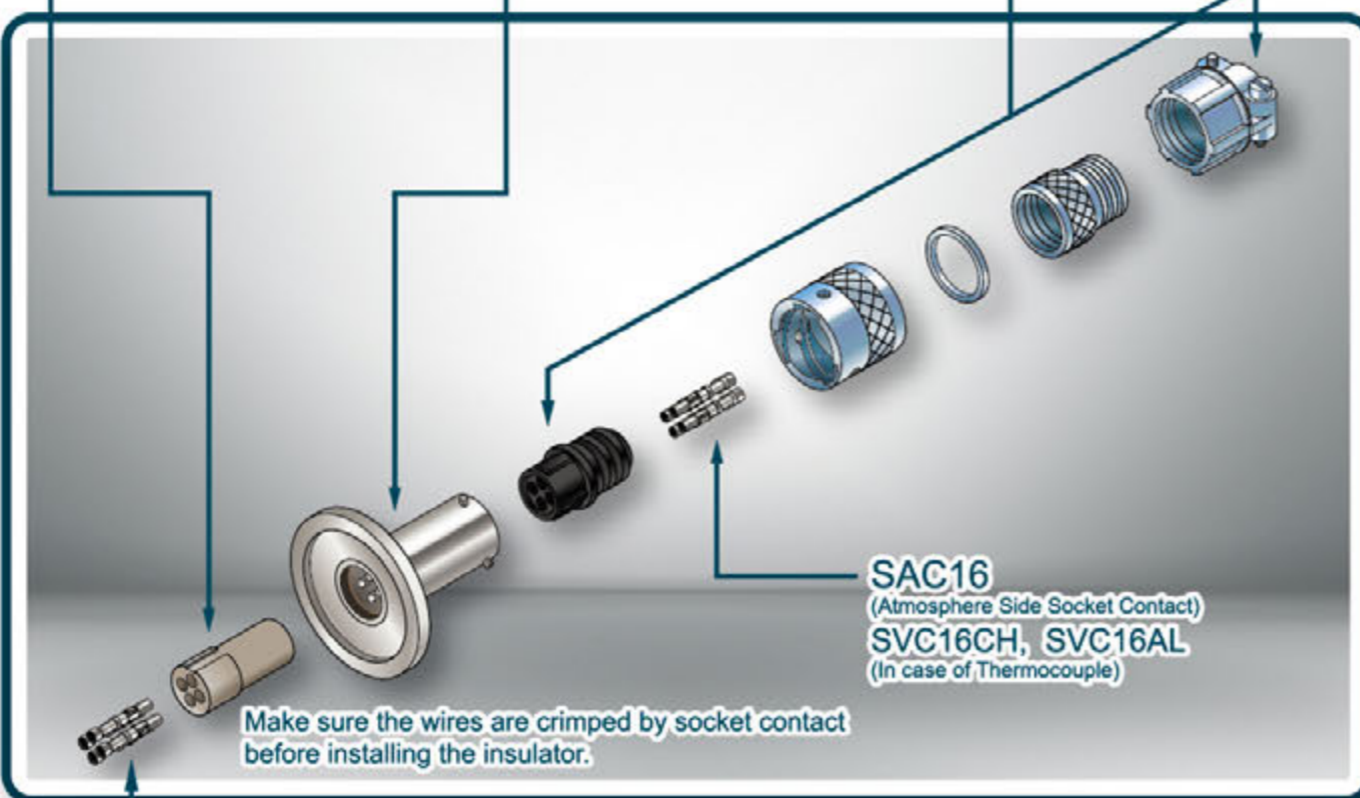

**Ex. in case of 4 PIN on NW / KF25 (Also, ConFlat® mount type is available)****VSP14**
(Vacuum Side PEEK® Insulator)**N25MB41****ASP4**
(Atmosphere Side Plug)
We provide this plug assembled.**SVC16**
(Vacuum Side Socket Contact)
SVC16CH, SVC16AL
(In case of Thermocouple)

Socket contact will be auto-locked when they were installed into the insulator.

We deeply recommend using removal tool PT16 when you take socket contact out from the insulator.

It is hard to take socket out from the insulator if you install socket contact into the insulator before crimping wire.

AWG #20 wire is suitable for socket contact SVC16 and SAC16.

Insulator (VSP14) and Plug (ASP4) product code will be change by last 1 or 2 digits that describes number of pins.

PEEK® insulator can be baked-out up to 250 °C.
Up to 300 °C version is available as VSAI(Vacuum Side Alumina Insulator)

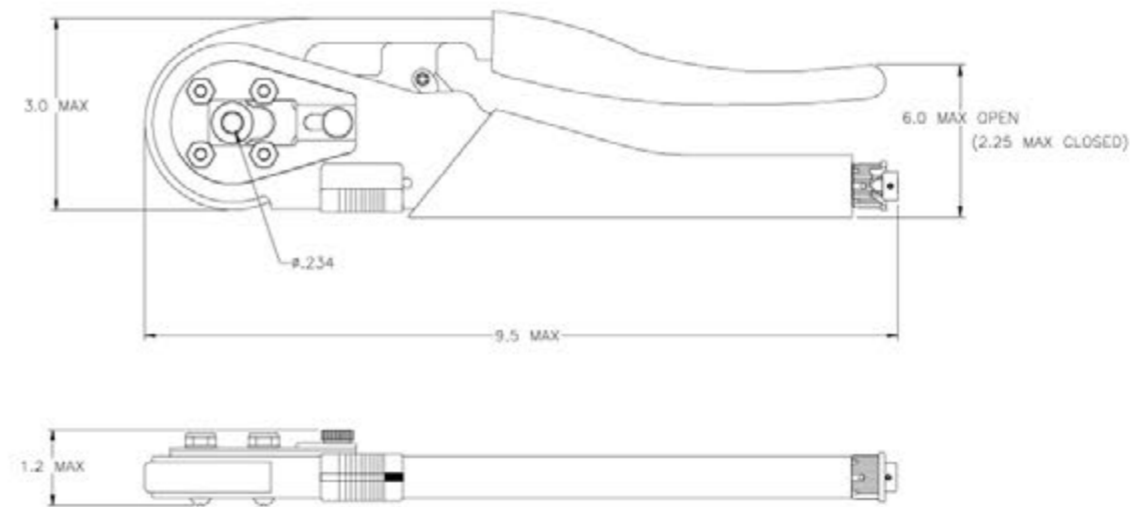
**GENERAL**

The CT2313 crimp tool is a micro adjustable, cycle controlled hand crimping tool. It is a fast, versatile and manually operated tool for crimping circular pin and socket contacts.

The tool is adjustable in a range of .025 to .075 inch. Settings to within .001 inch increments are possible for precision crimping. For long life and optimum performance, this tool should be kept clean and handled carefully, as any other precision instrument.

OPERATION

Open and close the tool several times and observe the precision cycle control ratchet mechanism. Note that the tool may not be opened or closed without completing the cycle.

To adjust the indenter opening, locate the adjustment window on the tool and observe where the red indicator is located.

Consult Data Plates on either side of the tool for gaging data. Pull and rotate the red adjustment knob, located at the end of the tool, until the indicator lines to increase, counter-clockwise to decrease opening. See figure #1.

It will be better to verify the opening by using cables which would be crimped. Close the tool completely and insert the cable between the indenters, as shown in figure #2.

The cable should be a ship-fit between the indenter trip with no sloppiness or free play. Re-adjust adjustment knob as necessary. Insert the pin or socket contacts with the cable between the indenters and crimp it.

AWG #	Solid wire size.	
	inch	mm
10	.1019	2.588
11	.0907	2.305
12	.0808	2.053
13	.072	1.828
14	.0641	1.628
15	.0571	1.45
16	.0508	1.291
17	.0453	1.15
18	.0403	1.024
19	.0359	0.912
20	.032	0.812
21	.0285	0.723
22	.0253	0.644
23	.0226	0.573
24	.0201	0.511
25	.0179	0.455
26	.0159	0.405
27	.0142	0.361
28	.0126	0.321
29	.0113	0.286
30	.01	0.255

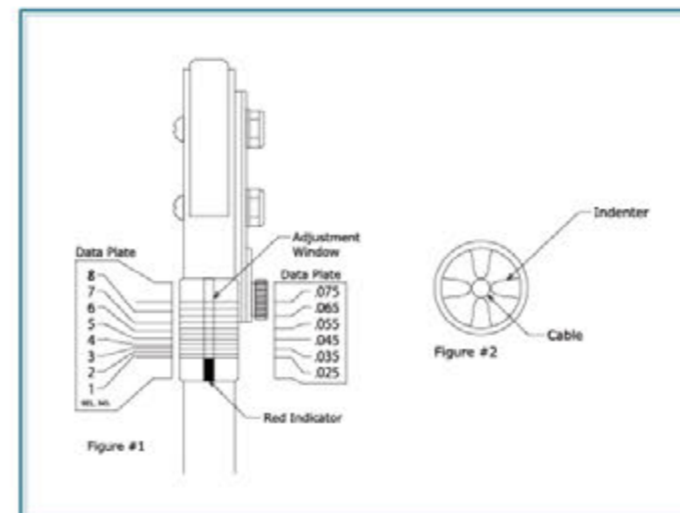



N40MB41 [10122]

Features

BURNDY (Bayonet Lock Connector) Standard Type

The BURNDY series is for measurement and control use and is rated to 500 V 3 A, which is compatible with the Bayonet Lock type plug.

The BURNDY series is offered from 4 pin to 48 pin. Because the BURNDY series is more compact than the MIL - C - 5015 series, a 48 pin can be welded to NW / KF 40 and ConFlat® 2.75". High current type with 10 A is available.

Select flange size and type from NW / KF, ConFlat®, ISO-K, ISO-F and ASA.

Accessories are available, including vacuum side insulators (PEEK® and CERAMICS), socket contacts, air side plugs, removal tools, and crimp tools.

We also manufacture custom-made products with quick delivery. Select welding position, number of connectors, and size of the custom-made flanges.

Materials

Flange	304 Stainless steel
Shell	Kovar®
Pins	Kovar®
Insulation	Alumina ceramic

Specifications

Type	Multipin BURNDY
BURNDY	4 PIN
Current: A Per Pins	3
Voltage: V max. DC	500
Max. Current all pins loaded	9.9
Insulation: ohm min.	10 ⁹
Frequency: MHz	DC or AC 10 (10 MHz)max.
Leak rate: 1.3×Pa · m ³ /s	10 ⁻¹⁰
Temperature Range: °C*	-196 to 300

*Temperature range will be changed depends on the connection.

NW / KF Flange

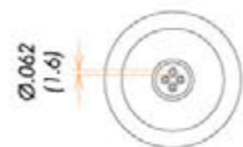
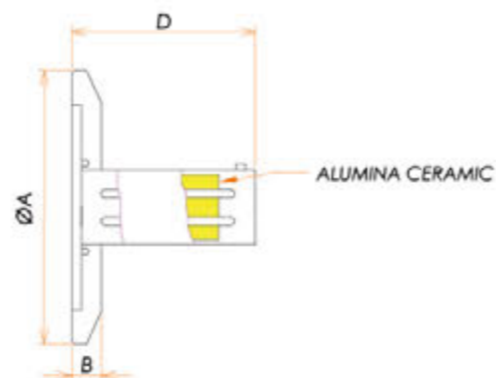

ConFlat® Flange

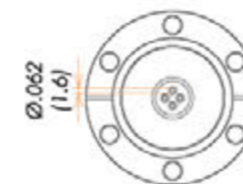
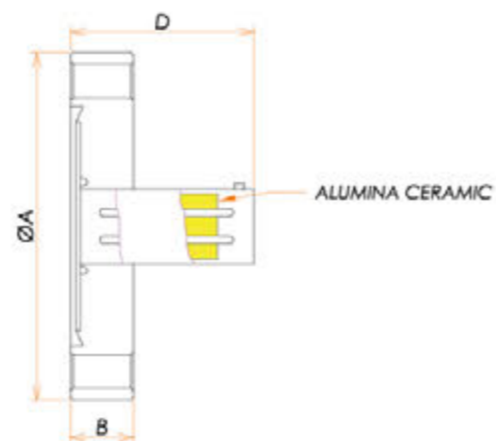

Dimensions in inches (mm)

NW / KF Flange

No. of Pins	INSTALLATION	A	B	D	REFERENCE	PART NUMBER
4	NW / KF 16	1.18 (30)	.24 (6)	1.48 (37.5)	N16MB41	10099
4	NW / KF 25	1.57 (40)	.24 (6)	1.48 (37.5)	N25MB41	10106
4	NW / KF 40	2.16 (55)	.24 (6)	1.48 (37.5)	N40MB41	10122

ConFlat® Flange

No. of Pins	INSTALLATION	A	B	D	REFERENCE	PART NUMBER
4	CF 1.33	1.33 (34)	.30 (7.5)	1.46 (37)	C34MB41	10027
4	CF 2.75	2.75 (70)	.50 (12.7)	1.46 (37)	C70MB41	10043

Accessories

Description	REFERENCE	PART NUMBER
4 Pin Vacuum Side PEEK® Insulator (250 °C MAX.)	VSPi4	10167
4 Pin Vacuum Side Alumina Insulator (300 °C MAX.)	VSAi4	10160
.062 Socket Contact Vacuum Side	SVC16	10147
.062 Socket Contact Air Side	SAC16	10142
4 Pin Air Side Plug	ASP4	10013
Removal Tool	PT16	10138
Crimp Tool (AWG #23 to #13)	CT2313	10052

For more details, see Section 6.2



N40MB81 [10124]

Features

BURNDY (Bayonet Lock Connector) Standard Type

The BURNDY series is for measurement and control use and is rated to 500 V 3 A, which is compatible with the Bayonet Lock type plug.

The BURNDY series is offered from 4 pin to 48 pin. Because the BURNDY series is more compact than the MIL - C - 5015 series, a 48 pin can be welded to NW / KF 40 and ConFlat® 2.75". High current type with 10 A is available.

Select flange size and type from NW / KF, ConFlat®, ISO-K, ISO-F and ASA.

Accessories are available, including vacuum side insulators (PEEK® and CERAMICS), socket contacts, air side plugs, removal tools, and crimp tools.

We also manufacture custom-made products with quick delivery. Select welding position, number of connectors, and size of the custom-made flanges.

Materials

Flange	304 Stainless steel
Shell	Kovar®
Pins	Kovar®
Insulation	Alumina ceramic

Specifications

Type	Multipin BURNDY
BURNDY	8 PIN
Current: A Per Pins	3
Voltage: V max. DC	500
Max. Current all pins loaded	14.4
Insulation: ohm min.	10 ⁹
Frequency: MHz	DC or AC 10 (10 MHz)max.
Leak rate: 1.3×Pa · m ³ /s	10 ⁻¹⁰
Temperature Range: °C*	-196 to 300

*Temperature range will be changed depends on the connection.

NW / KF Flange

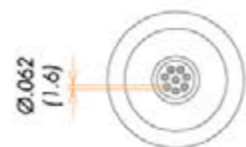
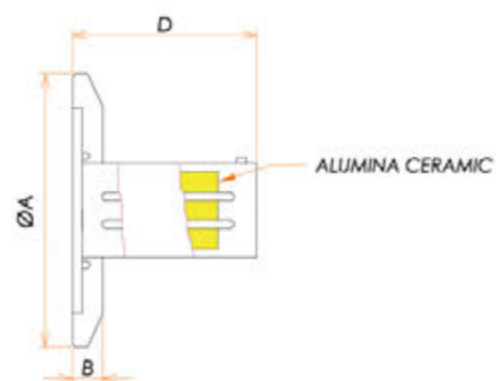

ConFlat® Flange

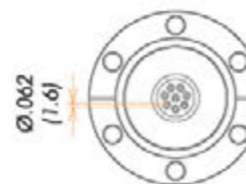
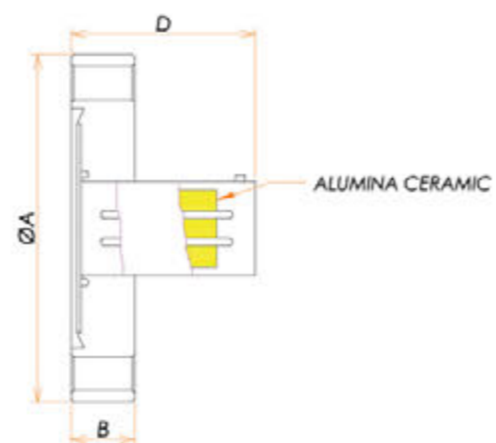

Dimensions in inches (mm)

NW / KF Flange

No. of Pins	INSTALLATION	A	B	D	REFERENCE	PART NUMBER
8	NW / KF 25	1.57 (40)	.24 (6)	1.48 (37.5)	N25MB81	10107
8	NW / KF 40	2.16 (55)	.24 (6)	1.48 (37.5)	N40MB81	10124

ConFlat® Flange

No. of Pins	INSTALLATION	A	B	D	REFERENCE	PART NUMBER
8	CF 1.33	1.33 (34)	.30 (7.5)	1.91 (48.5)	C34MB81	10028
8	CF 2.75	2.75 (70)	.50 (12.7)	1.46 (37)	C70MB81	10045

Accessories

Description	REFERENCE	PART NUMBER
8 Pin Vacuum Side PEEK® Insulator (250 °C MAX.)	VSPi8	10169
8 Pin Vacuum Side Alumina Insulator (300 °C MAX.)	VSAi8	10162
.062 Socket Contact Vacuum Side	SVC16	10147
.062 Socket Contact Air Side	SAC16	10142
8 Pin Air Side Plug	ASP8	10016
Removal Tool	PT16	10138
Crimp Tool (AWG #23 to #13)	CT2313	10052

For more details, see Section 6.2



N40MB121 [10180]

Features

BURNDY (Bayonet Lock Connector) Standard Type

The BURNDY series is for measurement and control use and is rated to 500 V 3 A, which is compatible with the Bayonet Lock type plug.

The BURNDY series is offered from 4 pin to 48 pin. Because the BURNDY series is more compact than the MIL - C - 5015 series, a 48 pin can be welded to NW / KF 40 and ConFlat® 2.75". High current type with 10 A is available.

Select flange size and type from NW / KF, ConFlat®, ISO-K, ISO-F and ASA.

Accessories are available, including vacuum side insulators (PEEK® and CERAMICS), socket contacts, air side plugs, removal tools, and crimp tools.

We also manufacture custom-made products with quick delivery. Select welding position, number of connectors, and size of the custom-made flanges.

Materials

Flange	304 Stainless steel
Shell	Kovar®
Pins	Kovar®
Insulation	Alumina ceramic

Specifications

Type	Multipin BURNDY
BURNDY	12 PIN
Current: A Per Pins	3
Voltage: V max. DC	500
Max. Current all pins loaded	13.3
Insulation: ohm min.	10 ⁹
Frequency: MHz	DC or AC 10 (10 MHz)max.
Leak rate: 1.3×Pa · m ³ /s	10 ⁻¹⁰
Temperature Range: °C*	-196 to 300

*Temperature range will be changed depends on the connection.

NW / KF Flange

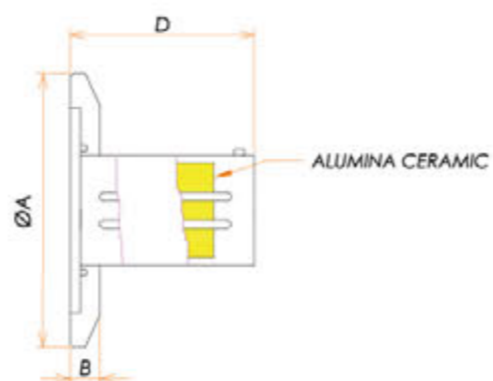

ConFlat® Flange

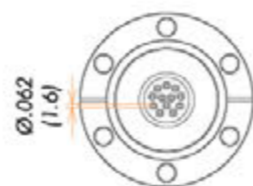
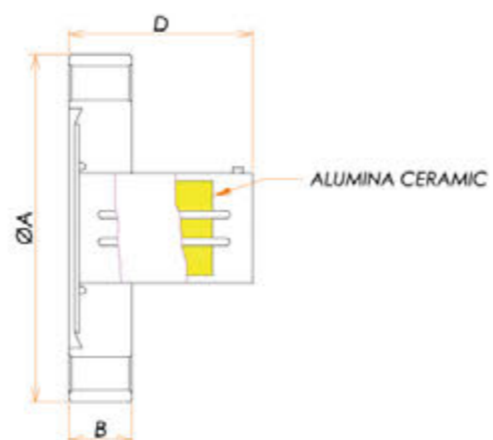

Dimensions in inches (mm)

NW / KF Flange

No. of Pins	INSTALLATION	A	B	D	REFERENCE	PART NUMBER
12	NW / KF 25	1.57 (40)	.24 (6)	1.48 (37.5)	N25MB121	10104
12	NW / KF 40	2.16 (55)	.24 (6)	1.48 (37.5)	N40MB121	10180

ConFlat® Flange

No. of Pins	INSTALLATION	A	B	D	REFERENCE	PART NUMBER
12	CF 2.75	2.75 (70)	.50 (12.7)	1.46 (37)	C70MB121	10040

Accessories

Description	REFERENCE	PART NUMBER
12 Pin Vacuum Side PEEK® Insulator (250 °C MAX.)	VSPI12	10163
12 Pin Vacuum Side Alumina Insulator (300 °C MAX.)	VSAI12	10157
.062 Socket Contact Vacuum Side	SVC16	10147
.062 Socket Contact Air Side	SAC16	10142
12 Pin Air Side Plug	ASP12	10005
Removal Tool	PT16	10138
Crimp Tool (AWG #23 to #13)	CT2313	10052

For more details, see Section 6.2



N40MB191 [10119]

Features

BURNDY (Bayonet Lock Connector) Standard Type

The BURNDY series is for measurement and control use and is rated to 500 V 3 A, which is compatible with the Bayonet Lock type plug.

The BURNDY series is offered from 4 pin to 48 pin. Because the BURNDY series is more compact than the MIL - C - 5015 series, a 48 pin can be welded to NW / KF 40 and ConFlat® 2.75". High current type with 10 A is available.

Select flange size and type from NW / KF, ConFlat®, ISO-K, ISO-F and ASA.

Accessories are available, including vacuum side insulators (PEEK® and CERAMICS), socket contacts, air side plugs, removal tools, and crimp tools.

We also manufacture custom-made products with quick delivery. Select welding position, number of connectors, and size of the custom-made flanges.

Materials

Flange	304 Stainless steel
Shell	Kovar®
Pins	Kovar®
Insulation	Alumina ceramic

Specifications

Type	Multipin BURNDY
BURNDY	19 PIN
Current: A Per Pins	3
Voltage: V max. DC	500
Max. Current all pins loaded	11.4
Insulation: ohm min.	10 ⁹
Frequency: MHz	DC or AC 10 (10 MHz)max.
Leak rate: 1.3×Pa · m ³ /s	10 ⁻¹⁰
Temperature Range: °C*	-196 to 300

*Temperature range will be changed depends on the connection.

NW / KF Flange

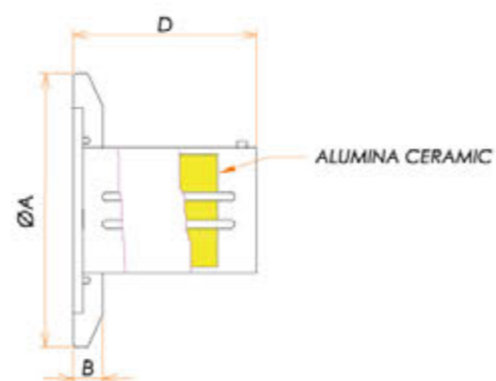

ConFlat® Flange

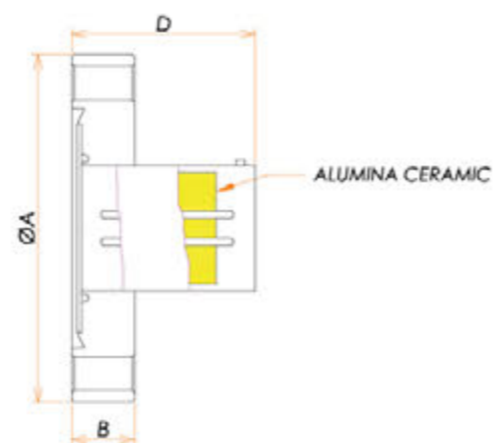

Dimensions in inches (mm)

NW / KF Flange

No. of Pins	INSTALLATION	A	B	D	REFERENCE	PART NUMBER
19	NW / KF 25	1.57 (40)	.24 (6)	1.48 (37.5)	N25MB191	10105
19	NW / KF 40	2.16 (55)	.24 (6)	1.48 (37.5)	N40MB191	10119

ConFlat® Flange

No. of Pins	INSTALLATION	A	B	D	REFERENCE	PART NUMBER
19	CF 2.75	2.75 (70)	.50 (12.7)	1.46 (37)	C70MB191	10041

Accessories

Description	REFERENCE	PART NUMBER
19 Pin Vacuum Side PEEK® Insulator (250 °C MAX.)	VSP19	10164
19 Pin Vacuum Side Alumina Insulator (300 °C MAX.)	VSAI19	10158
.062 Socket Contact Vacuum Side	SVC16	10147
.062 Socket Contact Air Side	SAC16	10142
19 Pin Air Side Plug	ASP19	10007
Removal Tool	PT16	10138
Crimp Tool (AWG #23 to #13)	CT2313	10052

For more details, see Section 6.2



C70MB221 [10042]

Features

BURNDY (Bayonet Lock Connector) Standard Type

The BURNDY series is for measurement and control use and is rated to 500 V 3 A, which is compatible with the Bayonet Lock type plug.

The BURNDY series is offered from 4 pin to 48 pin. Because the BURNDY series is more compact than the MIL - C - 5015 series, a 48 pin can be welded to NW / KF 40 and ConFlat® 2.75". High current type with 10 A is available.

Select flange size and type from NW / KF, ConFlat®, ISO-K, ISO-F and ASA.

Accessories are available, including vacuum side insulators (PEEK® and CERAMICS), socket contacts, air side plugs, removal tools, and crimp tools.

We also manufacture custom-made products with quick delivery. Select welding position, number of connectors, and size of the custom-made flanges.

Materials

Flange	304 Stainless steel
Shell	Kovar®
Pins	Kovar®
Insulation	Alumina ceramic

Specifications

Type	Multipin BURNDY
BURNDY	22 PIN
Current: A Per Pins	3
Voltage: V max. DC	500
Max. Current all pins loaded	13.2
Insulation: ohm min.	10 ⁹
Frequency: MHz	DC or AC 10 (10 MHz)max.
Leak rate: 1.3×Pa · m ³ /s	10 ⁻¹⁰
Temperature Range: °C*	-196 to 300

*Temperature range will be changed depends on the connection.

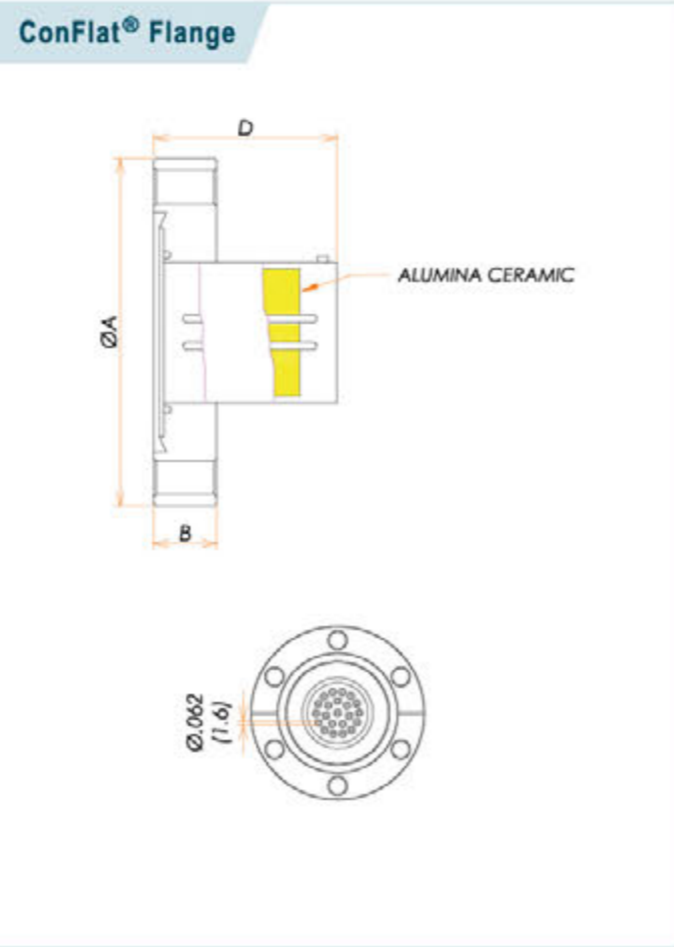
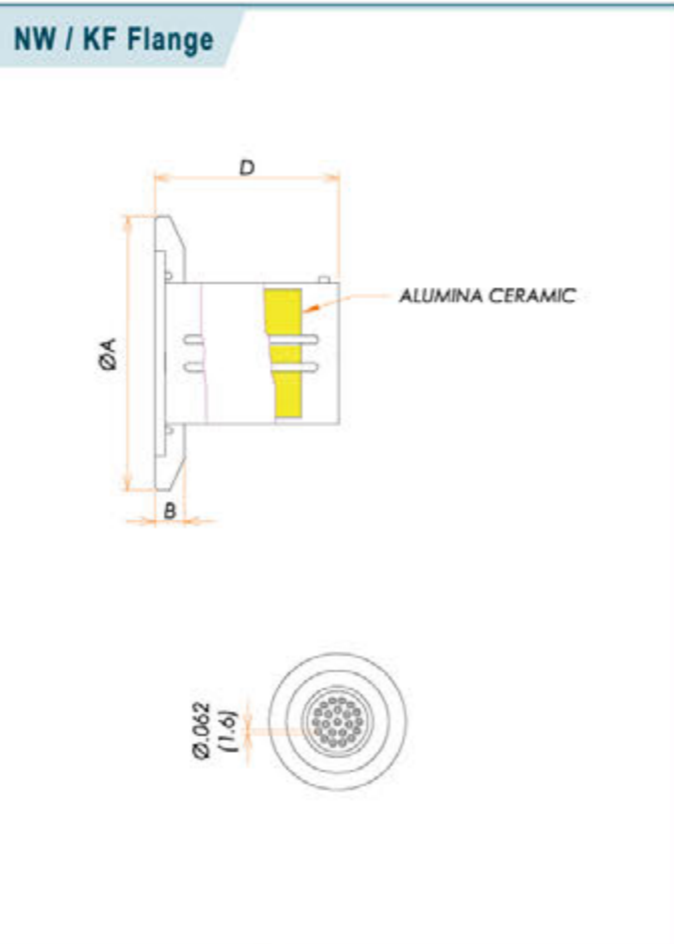

Dimensions in inches (mm)

NW / KF Flange						
No. of Pins	INSTALLATION	A	B	D	REFERENCE	PART NUMBER
22	NW / KF 40	2.16 (55)	.24 (6)	1.48 (37.5)	N40MB221	10120

ConFlat® Flange						
No. of Pins	INSTALLATION	A	B	D	REFERENCE	PART NUMBER
22	CF 2.75	2.75 (70)	.50 (12.7)	1.46 (37)	C70MB221	10042

Accessories

Description	REFERENCE	PART NUMBER
22 Pin Vacuum Side PEEK® Insulator (250 °C MAX.)	VSPI22	10165
22 Pin Vacuum Side Alumina Insulator (300 °C MAX.)	VSAI22	10159
.062 Socket Contact Vacuum Side	SVC16	10147
.062 Socket Contact Air Side	SAC16	10142
22 Pin Air Side Plug	ASP22	10009
Removal Tool	PT16	10138
Crimp Tool (AWG #23 to #13)	CT2313	10052

For more details, see Section 6.2

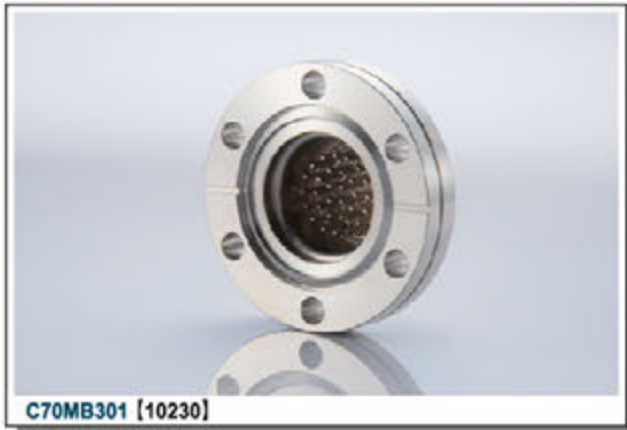

C70MB301 [10230]

Features

BURNDY (Bayonet Lock Connector) Standard Type

The BURNDY series is for measurement and control use and is rated to 500 V 3 A, which is compatible with the Bayonet Lock type plug.

The BURNDY series is offered from 4 pin to 48 pin. Because the BURNDY series is more compact than the MIL - C - 5015 series, a 48 pin can be welded to NW / KF 40 and ConFlat® 2.75". High current type with 10 A is available.

Select flange size and type from NW / KF, ConFlat®, ISO-K, ISO-F and ASA.

Accessories are available, including vacuum side insulators (PEEK® and CERAMICS), socket contacts, air side plugs, removal tools, and crimp tools.

We also manufacture custom-made products with quick delivery. Select welding position, number of connectors, and size of the custom-made flanges.

Materials

Flange	304 Stainless steel
Shell	Kovar®
Pins	Kovar®
Insulation	Alumina ceramic

Specifications

Type	Multipin BURNDY
BURNDY	30 PIN
Current: A Per Pins	3
Voltage: V max. DC	500
Max. Current all pins loaded	18
Insulation: ohm min.	10 ⁹
Frequency: MHz	DC or AC 10 (10 MHz)max.
Leak rate: 1.3×Pa · m ³ /s	10 ⁻¹⁰
Temperature Range: °C*	-196 to 300

*Temperature range will be changed depends on the connection.

NW / KF Flange

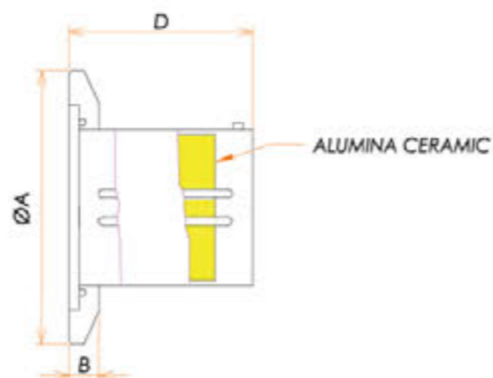

ConFlat® Flange

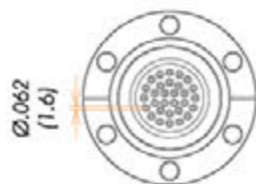
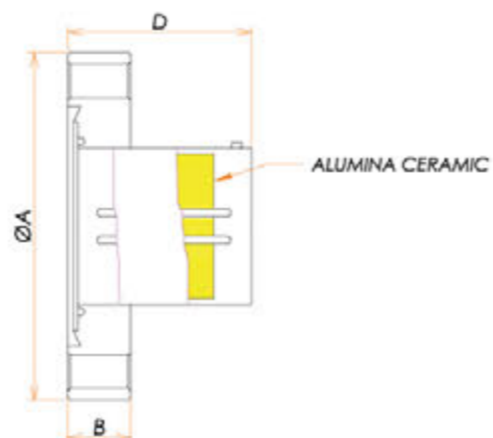

Dimensions in inches (mm)

NW / KF Flange

No. of Pins	INSTALLATION	A	B	D	REFERENCE	PART NUMBER
30	NW / KF 40	2.16 (55)	.24 (6)	1.48 (37.5)	N40MB301	10121

ConFlat® Flange

No. of Pins	INSTALLATION	A	B	D	REFERENCE	PART NUMBER
30	CF 2.75	2.75 (70)	.50 (12.7)	1.46 (37)	C70MB301	10230

Accessories

Description	REFERENCE	PART NUMBER
30 Pin Vacuum Side PEEK® Insulator (250 °C MAX.)	VSPI30	10166
.062 Socket Contact Vacuum Side	SVC16	10147
.062 Socket Contact Air Side	SAC16	10142
30 Pin Air Side Plug	ASP30	10011
Removal Tool	PT16	10138
Crimp Tool (AWG #23 to #13)	CT2313	10052

For more details, see Section 6.2

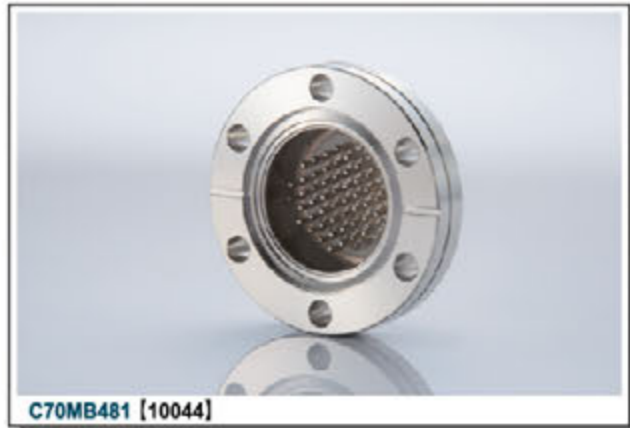

C70MB481 (10044)

Features

BURNDY (Bayonet Lock Connector) Standard Type

The BURNDY series is for measurement and control use and is rated to 500 V 3 A, which is compatible with the Bayonet Lock type plug.

The BURNDY series is offered from 4 pin to 48 pin. Because the BURNDY series is more compact than the MIL - C - 5015 series, a 48 pin can be welded to NW / KF 40 and ConFlat® 2.75". High current type with 10 A is available.

Select flange size and type from NW / KF, ConFlat®, ISO-K, ISO-F and ASA.

Accessories are available, including vacuum side insulators (PEEK® and CERAMICS), socket contacts, air side plugs, removal tools, and crimp tools.

We also manufacture custom-made products with quick delivery. Select welding position, number of connectors, and size of the custom-made flanges.

Materials

Flange	304 Stainless steel
Shell	Kovar®
Pins	Kovar®
Insulation	Alumina ceramic

Specifications

Type	Multipin BURNDY
BURNDY	48 PIN
Current: A Per Pins	3
Voltage: V max. DC	500
Max. Current all pins loaded	28.8
Insulation: ohm min.	10 ⁹
Frequency: MHz	DC or AC 10 (10 MHz)max.
Leak rate: 1.3×Pa · m ³ /s	10 ⁻¹⁰
Temperature Range: °C*	-196 to 300

*Temperature range will be changed depends on the connection.

NW / KF Flange

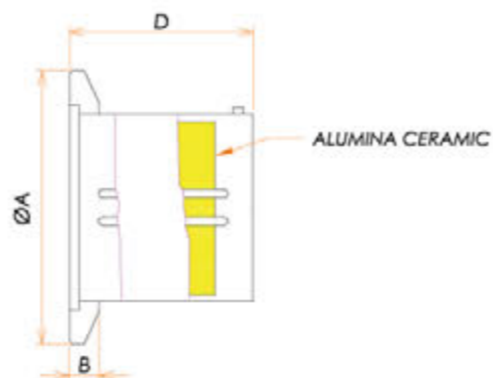

ConFlat® Flange

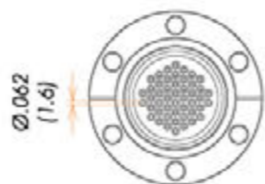
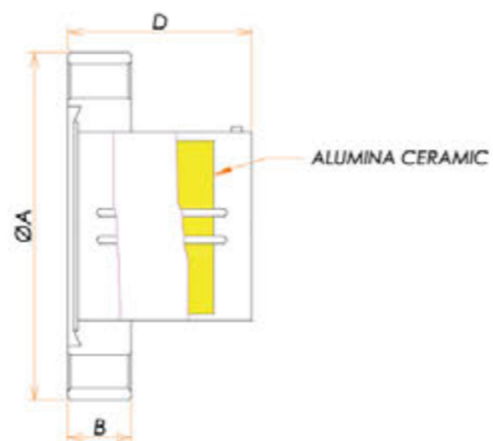

Dimensions in inches (mm)

NW / KF Flange

No. of Pins	INSTALLATION	A	B	D	REFERENCE	PART NUMBER
48	NW / KF 40	2.16 (55)	.24 (6)	1.48 (37.5)	N40MB481	10123

ConFlat® Flange

No. of Pins	INSTALLATION	A	B	D	REFERENCE	PART NUMBER
48	CF 2.75	2.75 (70)	.50 (12.7)	1.46 (37)	C70MB481	10044

Accessories

Description	REFERENCE	PART NUMBER
48 Pin Vacuum Side PEEK® Insulator (250 °C MAX.)	VSPI48	10168
48 Pin Vacuum Side Alumina Insulator (300 °C MAX.)	VSAI48	10161
.062 Socket Contact Vacuum Side	SVC16	10147
.062 Socket Contact Air Side	SAC16	10142
48 Pin Air Side Plug	ASP48	10014
Removal Tool	PT16	10138
Crimp Tool (AWG #23 to #13)	CT2313	10052

For more details, see Section 6.2



N40MB41AL [11153]

Features

BURNDY (Bayonet Lock Connector) High Current Type

The BURNDY series is for measurement and control use and is rated to 500 V 10 A compatible with the Bayonet Lock type plug. The BURNDY series is offered from 4 pin to 48 pin.

Because the BURNDY series is more compact than the MIL - C - 5015 series, 48 pin can be welded to NW / KF 40 and ConFlat® 2.75". Standard type with 3 A is available.

Select flange size and type from NW / KF, ConFlat®, ISO-K, ISO-F and ASA.

Accessories are available, including vacuum side insulators (PEEK® and CERAMICS), socket contacts, air side plugs, removal tools, and crimp tools.

We also manufacture custom-made products with quick delivery. Select welding position, number of connectors, and size of custom-made flanges.

Materials

Flange	304 Stainless steel
Shell	Kovar®
Pins	Alumel®
Insulation	Alumina ceramic

Specifications

Type	Multipin BURNDY
BURNDY	4 PIN
Current: A Per Pins	10
Voltage: V max. DC	500
Max. Current all pins loaded	33.1
Insulation: ohm min.	10 ⁹
Frequency: MHz	DC or AC 10 (10 MHz)max.
Leak rate: 1.3×Pa · m ³ /s	10 ⁻¹⁰
Temperature Range: °C*	-196 to 300

*Temperature range will be changed depends on the connection.

NW / KF Flange

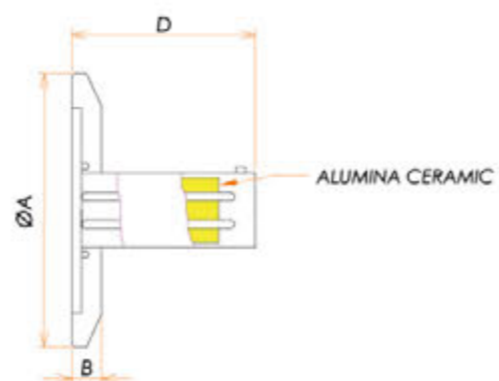

ConFlat® Flange

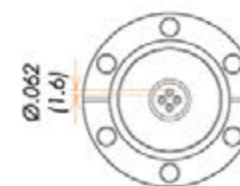
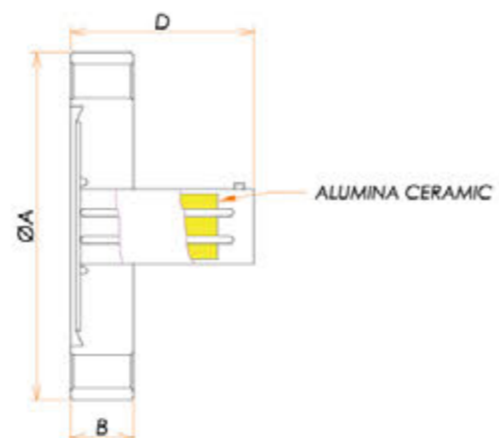

Dimensions in inches (mm)

NW / KF Flange

No. of Pins	INSTALLATION	A	B	D	REFERENCE	PART NUMBER
4	NW / KF 16	1.18 (30)	.24 (6)	1.48 (37.5)	N16MB41AL	11051
4	NW / KF 25	1.57 (40)	.24 (6)	1.48 (37.5)	N25MB41AL	11086
4	NW / KF 40	2.16 (55)	.24 (6)	1.48 (37.5)	N40MB41AL	11153

ConFlat® Flange

No. of Pins	INSTALLATION	A	B	D	REFERENCE	PART NUMBER
4	CF 1.33	1.33 (34)	.30 (7.5)	1.46 (37)	C34MB41AL	10625
4	CF 2.75	2.75 (70)	.50 (12.7)	1.46 (37)	C70MB41AL	12138

Accessories

Description	REFERENCE	PART NUMBER
4 Pin Vacuum Side PEEK® Insulator (250 °C MAX.)	VSPi4	10167
4 Pin Vacuum Side Alumina Insulator (300 °C MAX.)	VSAi4	10160
.062 Socket Contact Vacuum Side	SVC16	10147
.062 Socket Contact Air Side	SAC16	10142
4 Pin Air Side Plug	ASP4	10013
Removal Tool	PT16	10138
Crimp Tool (AWG #23 to #13)	CT2313	10052

For more details, see Section 6.2



N40MB81AL [11156]

Features

BURNDY (Bayonet Lock Connector) High Current Type

The BURNDY series is for measurement and control use and is rated to 500 V 10 A compatible with the Bayonet Lock type plug. The BURNDY series is offered from 4 pin to 48 pin.

Because the BURNDY series is more compact than the MIL - C - 5015 series, 48 pin can be welded to NW / KF 40 and ConFlat® 2.75". Standard type with 3 A is available.

Select flange size and type from NW / KF, ConFlat®, ISO-K, ISO-F and ASA.

Accessories are available, including vacuum side insulators (PEEK® and CERAMICS), socket contacts, air side plugs, removal tools, and crimp tools.

We also manufacture custom-made products with quick delivery. Select welding position, number of connectors, and size of custom-made flanges.

Materials

Flange	304 Stainless steel
Shell	Kovar®
Pins	Alumel®
Insulation	Alumina ceramic

Specifications

Type	Multipin BURNDY
BURNDY	8 PIN
Current: A Per Pins	10
Voltage: V max. DC	500
Max. Current all pins loaded	48.0
Insulation: ohm min.	10 ⁹
Frequency: MHz	DC or AC 10 (10 MHz)max.
Leak rate: 1.3×Pa · m ³ /s	10 ⁻¹⁰
Temperature Range: °C*	-196 to 300

*Temperature range will be changed depends on the connection.

NW / KF Flange

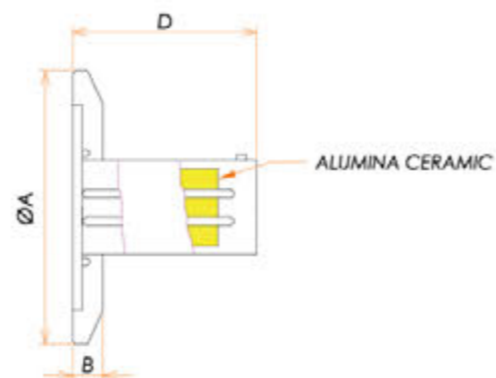

ConFlat® Flange

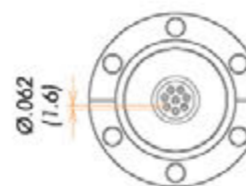
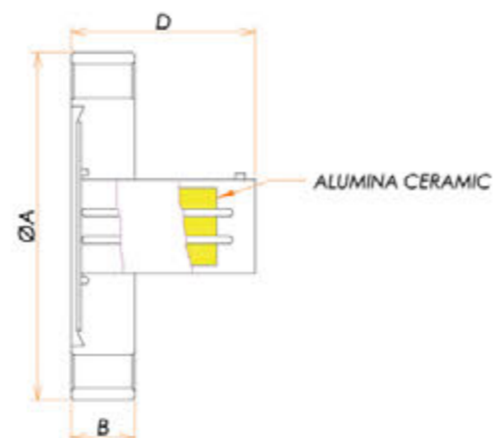

Dimensions in inches (mm)

NW / KF Flange

No. of Pins	INSTALLATION	A	B	D	REFERENCE	PART NUMBER
8	NW / KF 25	1.57 (40)	.24 (6)	1.48 (37.5)	N25MB81AL	11087
8	NW / KF 40	2.16 (55)	.24 (6)	1.48 (37.5)	N40MB81AL	11156

ConFlat® Flange

No. of Pins	INSTALLATION	A	B	D	REFERENCE	PART NUMBER
8	CF 1.33	1.33 (34)	.30 (7.5)	1.91 (48.5)	C34MB81AL	10626
8	CF 2.75	2.75 (70)	.50 (12.7)	1.46 (37)	C70MB81AL	12139

Accessories

Description	REFERENCE	PART NUMBER
8 Pin Vacuum Side PEEK® Insulator (250 °C MAX.)	VSPI8	10169
8 Pin Vacuum Side Alumina Insulator (300 °C MAX.)	VSAI8	10162
.062 Socket Contact Vacuum Side	SVC16	10147
.062 Socket Contact Air Side	SAC16	10142
8 Pin Air Side Plug	ASP8	10016
Removal Tool	PT16	10138
Crimp Tool (AWG #23 to #13)	CT2313	10052

For more details, see Section 6.2



Features

BURNDY (Bayonet Lock Connector) High Current Type

The BURNDY series is for measurement and control use and is rated to 500 V 10 A compatible with the Bayonet Lock type plug. The BURNDY series is offered from 4 pin to 48 pin.

Because the BURNDY series is more compact than the MIL - C - 5015 series, 48 pin can be welded to NW / KF 40 and ConFlat® 2.75". Standard type with 3 A is available.

Select flange size and type from NW / KF, ConFlat®, ISO-K, ISO-F and ASA.

Accessories are available, including vacuum side insulators (PEEK® and CERAMICS), socket contacts, air side plugs, removal tools, and crimp tools.

We also manufacture custom-made products with quick delivery. Select welding position, number of connectors, and size of custom-made flanges.

Materials

Flange	304 Stainless steel
Shell	Kovar®
Pins	Alumel®
Insulation	Alumina ceramic

Specifications

Type	Multipin BURNDY
BURNDY	12 PIN
Current: A Per Pins	10
Voltage: V max. DC	500
Max. Current all pins loaded	44.5
Insulation: ohm min.	10 ⁹
Frequency: MHz	DC or AC 10 (10 MHz)max.
Leak rate: 1.3×Pa · m ³ /s	10 ⁻¹⁰
Temperature Range: °C*	-196 to 300

*Temperature range will be changed depends on the connection.

NW / KF Flange

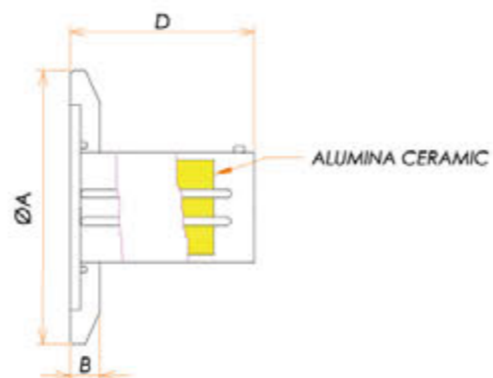

ConFlat® Flange

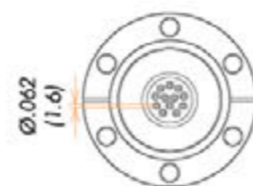
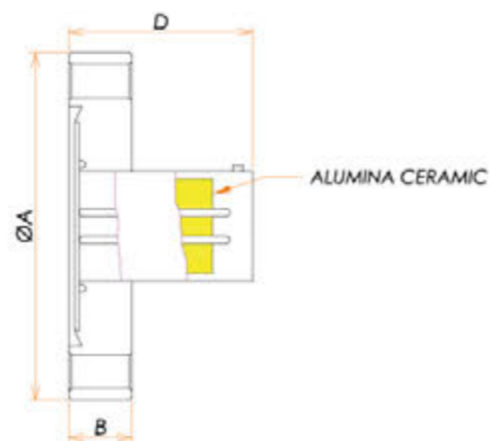

Dimensions in inches (mm)

NW / KF Flange

No. of Pins	INSTALLATION	A	B	D	REFERENCE	PART NUMBER
12	NW / KF 25	1.57 (40)	.24 (6)	1.48 (37.5)	N25MB121AL	11084
12	NW / KF 40	2.16 (55)	.24 (6)	1.48 (37.5)	N40MB121AL	11144

ConFlat® Flange

No. of Pins	INSTALLATION	A	B	D	REFERENCE	PART NUMBER
12	CF 2.75	2.75 (70)	.50 (12.7)	1.46 (37)	C70MB121AL	10699

Accessories

Description	REFERENCE	PART NUMBER
12 Pin Vacuum Side PEEK® Insulator (250 °C MAX.)	VSP12	10163
12 Pin Vacuum Side Alumina Insulator (300 °C MAX.)	VSAI12	10157
.062 Socket Contact Vacuum Side	SVC16	10147
.062 Socket Contact Air Side	SAC16	10142
12 Pin Air Side Plug	ASP12	10005
Removal Tool	PT16	10138
Crimp Tool (AWG #23 to #13)	CT2313	10052

For more details, see Section 6.2



Features

BURNDY (Bayonet Lock Connector) High Current Type

The BURNDY series is for measurement and control use and is rated to 500 V 10 A compatible with the Bayonet Lock type plug. The BURNDY series is offered from 4 pin to 48 pin. Because the BURNDY series is more compact than the MIL - C - 5015 series, 48 pin can be welded to NW / KF 40 and ConFlat® 2.75". Standard type with 3 A is available. Select flange size and type from NW / KF, ConFlat®, ISO-K, ISO-F and ASA. Accessories are available, including vacuum side insulators (PEEK® and CERAMICS), socket contacts, air side plugs, removal tools, and crimp tools. We also manufacture custom-made products with quick delivery. Select welding position, number of connectors, and size of custom-made flanges.

Materials

Flange	304 Stainless steel
Shell	Kovar®
Pins	Alumel®
Insulation	Alumina ceramic

Specifications

Type	Multipin BURNDY
BURNDY	19 PIN
Current: A Per Pins	10
Voltage: V max. DC	500
Max. Current all pins loaded	38.0
Insulation: ohm min.	10 ⁹
Frequency: MHz	DC or AC 10 (10 MHz)max.
Leak rate: 1.3×Pa · m ³ /s	10 ⁻¹⁰
Temperature Range: °C*	-196 to 300

*Temperature range will be changed depends on the connection.

NW / KF Flange

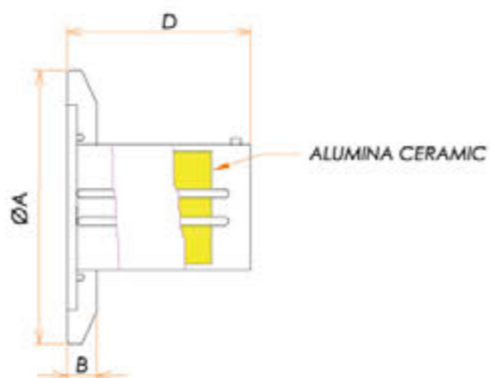

ConFlat® Flange

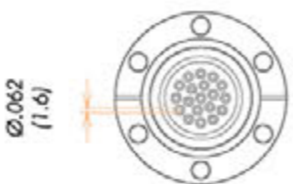
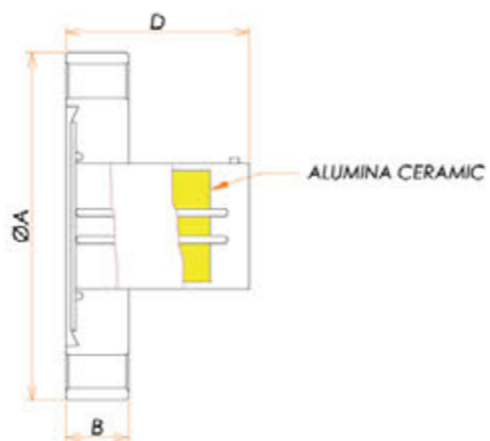

Dimensions in inches (mm)

NW / KF Flange

No. of Pins	INSTALLATION	A	B	D	REFERENCE	PART NUMBER
19	NW / KF 25	1.57 (40)	.24 (6)	1.48 (37.5)	N25MB191AL	11085
19	NW / KF 40	2.16 (55)	.24 (6)	1.48 (37.5)	N40MB191AL	12143

ConFlat® Flange

No. of Pins	INSTALLATION	A	B	D	REFERENCE	PART NUMBER
19	CF 2.75	2.75 (70)	.50 (12.7)	1.46 (37)	C70MB191AL	12140

Accessories

Description	REFERENCE	PART NUMBER
19 Pin Vacuum Side PEEK® Insulator (250 °C MAX.)	VSP19	10164
19 Pin Vacuum Side Alumina Insulator (300 °C MAX.)	VSAI19	10158
.062 Socket Contact Vacuum Side	SVC16	10147
.062 Socket Contact Air Side	SAC16	10142
19 Pin Air Side Plug	ASP19	10007
Removal Tool	PT16	10138
Crimp Tool (AWG #23 to #13)	CT2313	10052

For more details, see Section 6.2



C70MB221AL [10701]

Features

BURNDY (Bayonet Lock Connector) High Current Type

The BURNDY series is for measurement and control use and is rated to 500 V 10 A compatible with the Bayonet Lock type plug. The BURNDY series is offered from 4 pin to 48 pin. Because the BURNDY series is more compact than the MIL - C - 5015 series, 48 pin can be welded to NW / KF 40 and ConFlat® 2.75". Standard type with 3 A is available. Select flange size and type from NW / KF, ConFlat®, ISO-K, ISO-F and ASA. Accessories are available, including vacuum side insulators (PEEK® and CERAMICS), socket contacts, air side plugs, removal tools, and crimp tools. We also manufacture custom-made products with quick delivery. Select welding position, number of connectors, and size of custom-made flanges.

Materials

Flange	304 Stainless steel
Shell	Kovar®
Pins	Alumel®
Insulation	Alumina ceramic

Specifications

Type	Multipin BURNDY
BURNDY	22 PIN
Current: A Per Pins	10
Voltage: V max. DC	500
Max. Current all pins loaded	44.0
Insulation: ohm min.	10 ⁹
Frequency: MHz	DC or AC 10 (10 MHz)max.
Leak rate: 1.3×Pa · m ³ /s	10 ⁻¹⁰
Temperature Range: °C*	-196 to 300

*Temperature range will be changed depends on the connection.

NW / KF Flange

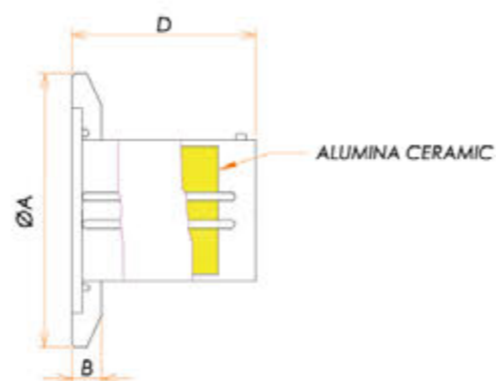

ConFlat® Flange

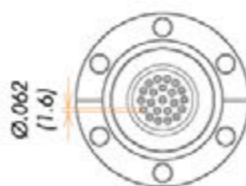
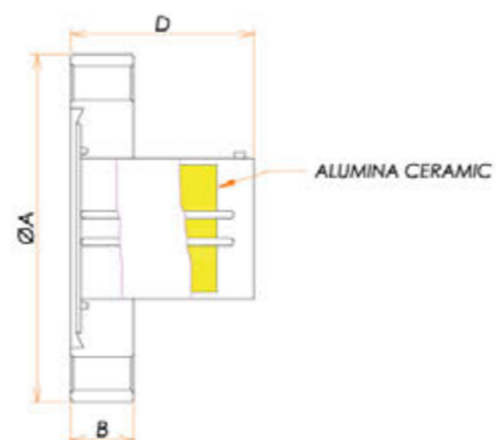

Dimensions in inches (mm)

NW / KF Flange

No. of Pins	INSTALLATION	A	B	D	REFERENCE	PART NUMBER
22	NW / KF 40	2.16 (55)	.24 (6)	1.48 (37.5)	N40MB221AL	11147

ConFlat® Flange

No. of Pins	INSTALLATION	A	B	D	REFERENCE	PART NUMBER
22	CF 2.75	2.75 (70)	.50 (12.7)	1.46 (37)	C70MB221AL	10701

Accessories

Description	REFERENCE	PART NUMBER
22 Pin Vacuum Side PEEK® Insulator (250 °C MAX.)	VSPI22	10165
22 Pin Vacuum Side Alumina Insulator (300 °C MAX.)	VSAI22	10159
.062 Socket Contact Vacuum Side	SVC16	10147
.062 Socket Contact Air Side	SAC16	10142
22 Pin Air Side Plug	ASP22	10009
Removal Tool	PT16	10138
Crimp Tool (AWG #23 to #13)	CT2313	10052

For more details, see Section 6.2



C70MB301AL [12141]

Features

BURNDY (Bayonet Lock Connector) High Current Type

The BURNDY series is for measurement and control use and is rated to 500 V 10 A compatible with the Bayonet Lock type plug. The BURNDY series is offered from 4 pin to 48 pin.

Because the BURNDY series is more compact than the MIL - C - 5015 series, 48 pin can be welded to NW / KF 40 and ConFlat® 2.75". Standard type with 3 A is available.

Select flange size and type from NW / KF, ConFlat®, ISO-K, ISO-F and ASA.

Accessories are available, including vacuum side insulators (PEEK® and CERAMICS), socket contacts, air side plugs, removal tools, and crimp tools.

We also manufacture custom-made products with quick delivery. Select welding position, number of connectors, and size of custom-made flanges.

Materials

Flange	304 Stainless steel
Shell	Kovar®
Pins	Alumel®
Insulation	Alumina ceramic

Specifications

Type	Multipin BURNDY
BURNDY	30 PIN
Current: A Per Pins	10
Voltage: V max. DC	500
Max. Current all pins loaded	60.0
Insulation: ohm min.	10 ⁹
Frequency: MHz	DC or AC 10 (10 MHz)max.
Leak rate: 1.3×Pa · m ³ /s	10 ⁻¹⁰
Temperature Range: °C*	-196 to 300

*Temperature range will be changed depends on the connection.

NW / KF Flange

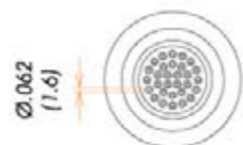
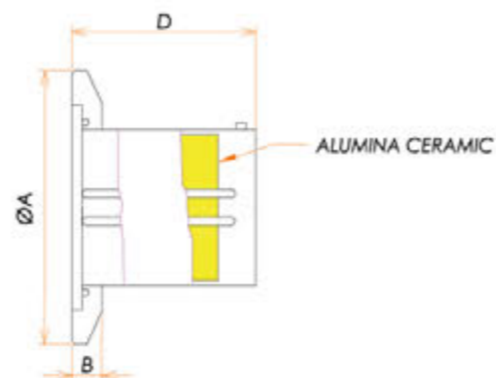

ConFlat® Flange

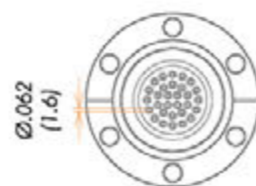
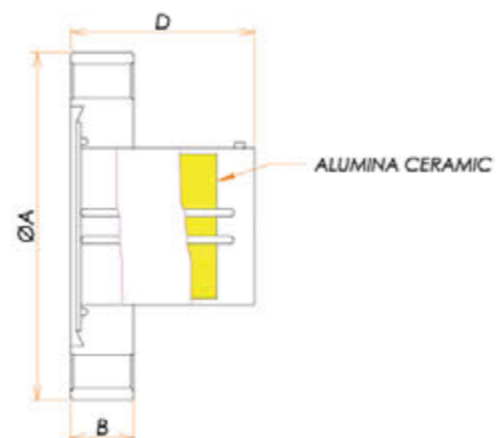

Dimensions in inches (mm)

NW / KF Flange

No. of Pins	INSTALLATION	A	B	D	REFERENCE	PART NUMBER
30	NW / KF 40	2.16 (55)	.24 (6)	1.48 (37.5)	N40MB301AL	11151

ConFlat® Flange

No. of Pins	INSTALLATION	A	B	D	REFERENCE	PART NUMBER
30	CF 2.75	2.75 (70)	.50 (12.7)	1.46 (37)	C70MB301AL	12141

Accessories

Description	REFERENCE	PART NUMBER
30 Pin Vacuum Side PEEK® Insulator (250 °C MAX.)	VSPI30	10166
.062 Socket Contact Vacuum Side	SVC16	10147
.062 Socket Contact Air Side	SAC16	10142
30 Pin Air Side Plug	ASP30	10011
Removal Tool	PT16	10138
Crimp Tool (AWG #23 to #13)	CT2313	10052

For more details, see Section 6.2

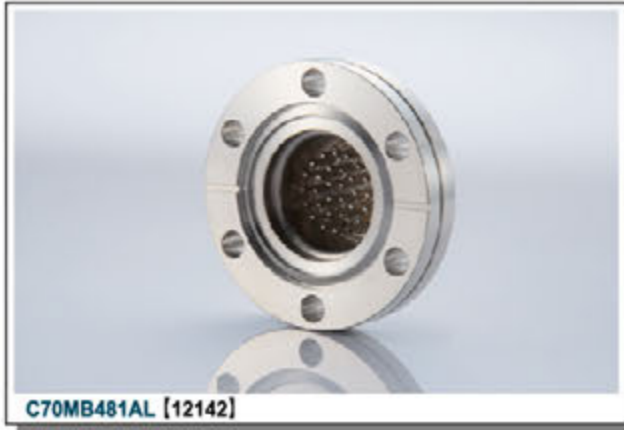

C70MB481AL (12142)

Features

BURNDY (Bayonet Lock Connector) High Current Type

The BURNDY series is for measurement and control use and is rated to 500 V 10 A compatible with the Bayonet Lock type plug. The BURNDY series is offered from 4 pin to 48 pin. Because the BURNDY series is more compact than the MIL - C - 5015 series, 48 pin can be welded to NW / KF 40 and ConFlat® 2.75". Standard type with 3 A is available. Select flange size and type from NW / KF, ConFlat®, ISO-K, ISO-F and ASA. Accessories are available, including vacuum side insulators (PEEK® and CERAMICS), socket contacts, air side plugs, removal tools, and crimp tools. We also manufacture custom-made products with quick delivery. Select welding position, number of connectors, and size of custom-made flanges.

Materials

Flange	304 Stainless steel
Shell	Kovar®
Pins	Alumel®
Insulation	Alumina ceramic

Specifications

Type	Multipin BURNDY
BURNDY	48 PIN
Current: A Per Pins	10
Voltage: V max. DC	500
Max. Current all pins loaded	96.0
Insulation: ohm min.	10 ⁹
Frequency: MHz	DC or AC 10 (10 MHz)max.
Leak rate: 1.3×Pa · m ³ /s	10 ⁻¹⁰
Temperature Range: °C*	-196 to 300

*Temperature range will be changed depends on the connection.

NW / KF Flange

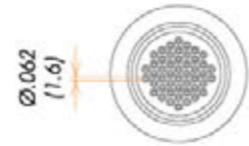
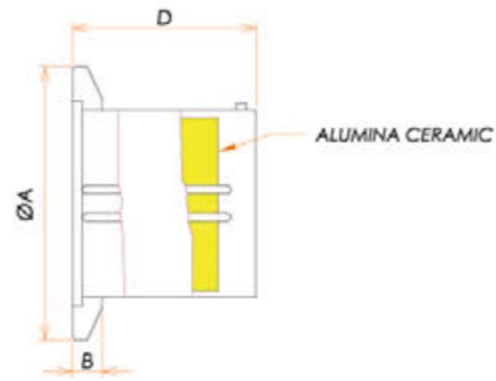

ConFlat® Flange

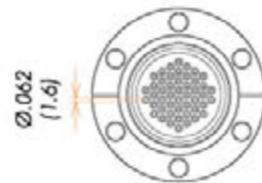
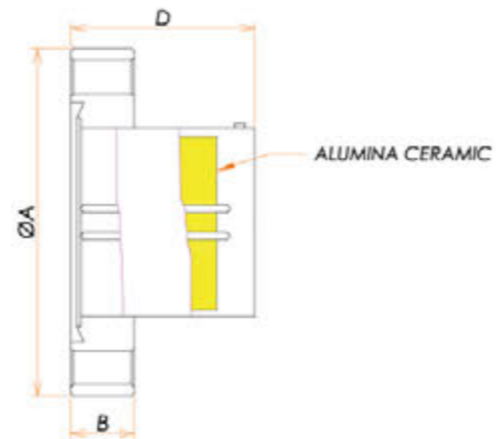

Dimensions in inches (mm)

NW / KF Flange

No. of Pins	INSTALLATION	A	B	D	REFERENCE	PART NUMBER
48	NW / KF 40	2.16 (55)	.24 (6)	1.48 (37.5)	N40MB481AL	11154

ConFlat® Flange

No. of Pins	INSTALLATION	A	B	D	REFERENCE	PART NUMBER
48	CF 2.75	2.75 (70)	.50 (12.7)	1.46 (37)	C70MB481AL	12142

Accessories

Description	REFERENCE	PART NUMBER
48 Pin Vacuum Side PEEK® Insulator (250 °C MAX.)	VSP148	10168
48 Pin Vacuum Side Alumina Insulator (300 °C MAX.)	VSA148	10161
.062 Socket Contact Vacuum Side	SVC16	10147
.062 Socket Contact Air Side	SAC16	10142
48 Pin Air Side Plug	ASP48	10014
Removal Tool	PT16	10138
Crimp Tool (AWG #23 to #13)	CT2313	10052

For more details, see Section 6.2



C70MM61 (10048)

Features

MIL-C-5015

The MIL - C - 5015 series is for measurement and control use and is rated to 500 V 3 A, compatible with the MIL - C - 5015 plug. The MS series is offered from 4 pin to 48 pin.

Select flange size and type from NW / KF, ConFlat®, ISO-K, ISO-F and ASA.

Accessories are available, including vacuum side insulators (PEEK®), socket contacts, air side plugs, removal tools, and crimp tools.

We also manufacture custom-made products with quick delivery. Select welding position, number of connectors, and size of custom-made flanges.

Materials

Flange	304 Stainless steel
Shell	Kovar®
Pins	Kovar®
Insulation	Alumina ceramic

Specifications

Type	Multipin MS
MIL-C-5015	6 PIN
Current: A Per Pins	3
Voltage: V max. DC	500
Max. Current all pins loaded	12.8
Insulation: ohm min.	10 ⁹
Frequency: MHz	DC or AC 10 (10 MHz)max.
Leak rate: 1.3×Pa · m ³ /s	10 ⁻¹⁰
Temperature Range: °C*	-196 to 300

*Temperature range will be changed depends on the connection.

NW / KF Flange

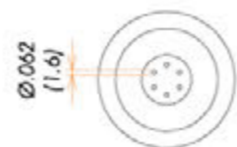
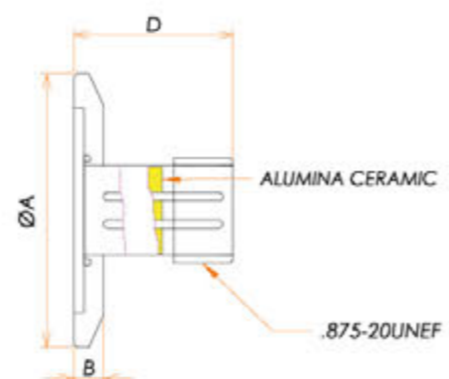

ConFlat® Flange

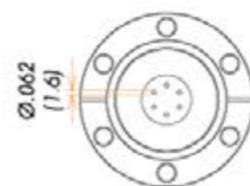
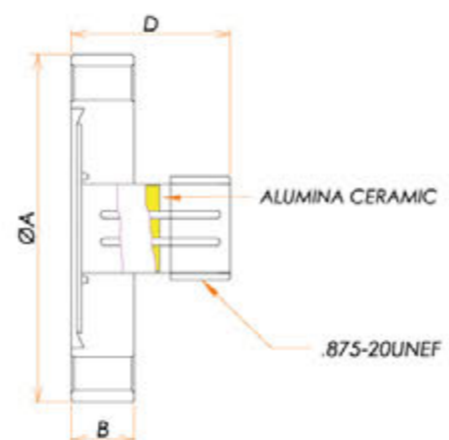

Dimensions in inches (mm)

NW / KF Flange

No. of Pins	INSTALLATION	A	B	D	REFERENCE	PART NUMBER
6	NW / KF 16	1.18 (30)	.24 (6)	1.57 (40)	N16MM61	10209
6	NW / KF 25	1.57 (40)	.24 (6)	1.28 (32.5)	N25MM61	10108
6	NW / KF 40	2.16 (55)	.24 (6)	1.28 (32.57)	N40MM61	10440

ConFlat® Flange

No. of Pins	INSTALLATION	A	B	D	REFERENCE	PART NUMBER
6	CF 1.33	1.33 (34)	.30 (7.5)	1.70 (43)	C34MM61	10029
6	CF 2.75	2.75 (70)	.50 (12.7)	1.26 (32)	C70MM61	10048

Accessories

Description	REFERENCE	PART NUMBER
MS 6 Pin Vacuum Side PEEK® Insulator (250 °C MAX.)	VSP16MS	10220
.062 Socket Contact Vacuum Side	SVC16	10147
MS 6 Pin Air Side Plug	ASP6MS	10015
Removal Tool	PT16	10138
Crimp Tool (AWG #23 to #13)	CT2313	10052

For more details, see Section 6.2



C70MM101 [10176]

Features

MIL-C-5015

The MIL - C - 5015 series is for measurement and control use and is rated to 500 V 3 A, compatible with the MIL - C - 5015 plug. The MS series is offered from 4 pin to 48 pin. Select flange size and type from NW / KF, ConFlat®, ISO-K, ISO-F and ASA. Accessories are available, including vacuum side insulators (PEEK®), socket contacts, air side plugs, removal tools, and crimp tools. We also manufacture custom-made products with quick delivery. Select welding position, number of connectors, and size of custom-made flanges.

Materials

Flange	304 Stainless steel
Shell	Kovar®
Pins	Kovar®
Insulation	Alumina ceramic

Specifications

Type	Multipin MS
MIL-C-5015	10 PIN
Current: A Per Pins	3
Voltage: V max. DC	500
Max. Current all pins loaded	14.5
Insulation: ohm min.	10 ⁹
Frequency: MHz	DC or AC 10 (10 MHz)max.
Leak rate: 1.3×Pa · m³/s	10 ⁻¹⁰
Temperature Range: °C*	-196 to 300

*Temperature range will be changed depends on the connection.

NW / KF Flange

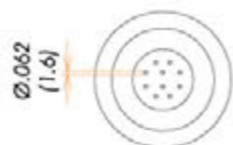
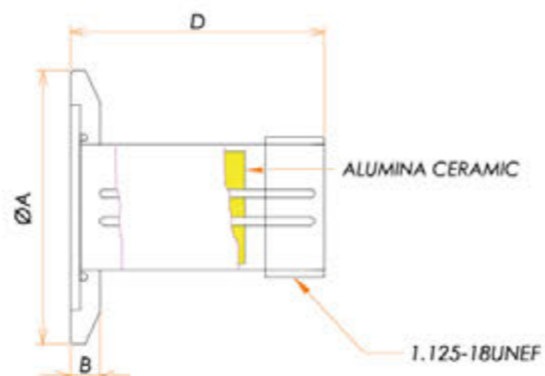

ConFlat® Flange

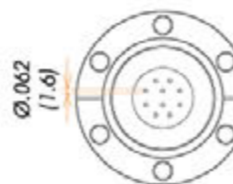
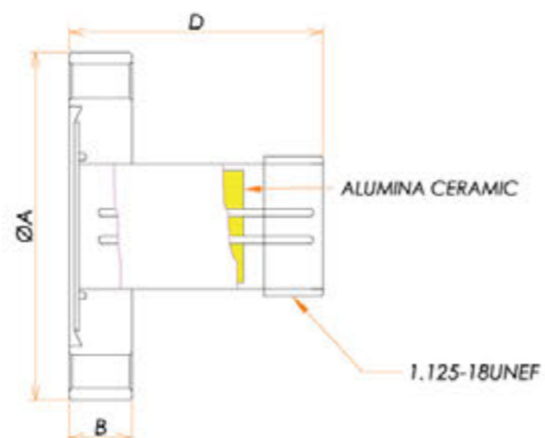

Dimensions in inches (mm)

NW / KF Flange

No. of Pins	INSTALLATION	A	B	D	REFERENCE	PART NUMBER
10	NW / KF 25	1.57 (40)	.24 (6)	2.03 (51.5)	N25MM101	10178
10	NW / KF 40	2.16 (55)	.24 (6)	2.03 (51.5)	N40MM101	10125

ConFlat® Flange

No. of Pins	INSTALLATION	A	B	D	REFERENCE	PART NUMBER
10	CF 2.75	2.75 (70)	.50 (12.7)	2.01 (51)	C70MM101	10176

Accessories

Description	REFERENCE	PART NUMBER
MS 10 Pin Vacuum Side PEEK® Insulator (250 °C MAX.)	VSP10MS	10217
.062 Socket Contact Vacuum Side	SVC16	10147
MS 10 Pin Air Side Plug	ASP10MS	10004
Removal Tool	PT16	10138
Crimp Tool (AWG #23 to #13)	CT2313	10052

For more details, see Section 6.2



C70MM141 [10348]

Features

MIL-C-5015

The MIL - C - 5015 series is for measurement and control use and is rated to 500 V 3 A, compatible with the MIL - C - 5015 plug.

The MS series is offered from 4 pin to 48 pin.

Select flange size and type from NW / KF, ConFlat®, ISO-K, ISO-F and ASA.

Accessories are available, including vacuum side insulators (PEEK®), socket contacts, air side plugs, removal tools, and crimp tools.

We also manufacture custom-made products with quick delivery. Select welding position, number of connectors, and size of custom-made flanges.

Materials

Flange	304 Stainless steel
Shell	Kovar®
Pins	Kovar®
Insulation	Alumina ceramic

Specifications

Type	Multipin MS
MIL-C-5015	14 PIN
Current: A Per Pins	3
Voltage: V max. DC	500
Max. Current all pins loaded	10.7
Insulation: ohm min.	10 ⁹
Frequency: MHz	DC or AC 10 (10 MHz)max.
Leak rate: 1.3×Pa · m ³ /s	10 ⁻¹⁰
Temperature Range: °C*	-196 to 300

*Temperature range will be changed depends on the connection.

NW / KF Flange

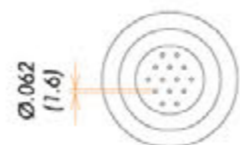
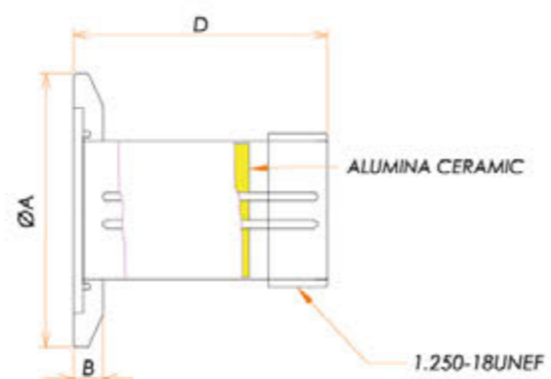

ConFlat® Flange

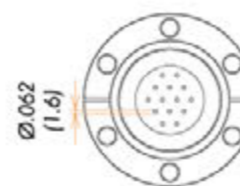
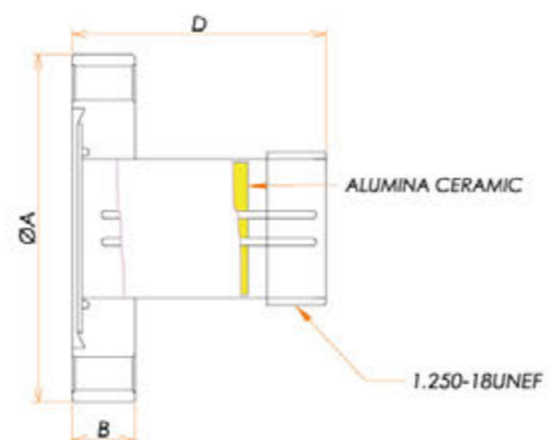

Dimensions in inches (mm)

NW / KF Flange

No. of Pins	INSTALLATION	A	B	D	REFERENCE	PART NUMBER
14	NW / KF 25	1.57 (40)	.24 (6)	2.32 (59.0)	N25MM141	10204
14	NW / KF 40	2.16 (55)	.24 (6)	2.03 (51.5)	N40MM141	10229

ConFlat® Flange

No. of Pins	INSTALLATION	A	B	D	REFERENCE	PART NUMBER
14	CF 2.75	2.75 (70)	.50 (12.7)	2.01 (51)	C70MM141	10348

Accessories

Description	REFERENCE	PART NUMBER
MS 14 Pin Vacuum Side PEEK® Insulator (250 °C MAX.)	VSP14MS	10216
.062 Socket Contact Vacuum Side	SVC16	10147
MS 14 Pin Air Side Plug	ASP14MS	10006
Removal Tool	PT16	10138
Crimp Tool (AWG #23 to #13)	CT2313	10052

For more details, see Section 6.2



N40MM191 [10223]

Features

MIL-C-5015

The MIL - C - 5015 series is for measurement and control use and is rated to 500 V 3 A, compatible with the MIL - C - 5015 plug. The MS series is offered from 4 pin to 48 pin.

Select flange size and type from NW / KF, ConFlat®, ISO-K, ISO-F and ASA.

Accessories are available, including vacuum side insulators (PEEK®), socket contacts, air side plugs, removal tools, and crimp tools.

We also manufacture custom-made products with quick delivery. Select welding position, number of connectors, and size of custom-made flanges.

Materials

Flange	304 Stainless steel
Shell	Kovar®
Pins	Kovar®
Insulation	Alumina ceramic

Specifications

Type	Multipin MS
MIL-C-5015	19 PIN
Current: A Per Pins	3
Voltage: V max. DC	500
Max. Current all pins loaded	11.4
Insulation: ohm min.	10 ⁹
Frequency: MHz	DC or AC 10 (10 MHz)max.
Leak rate: 1.3×Pa · m ³ /s	10 ⁻¹⁰
Temperature Range: °C*	-196 to 300

*Temperature range will be changed depends on the connection.

NW / KF Flange

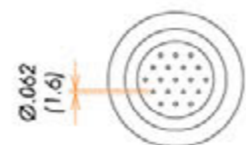
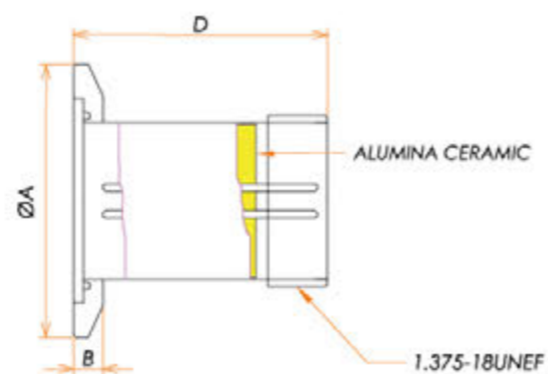

ConFlat® Flange

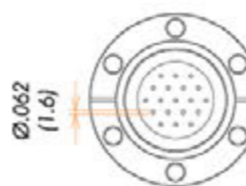
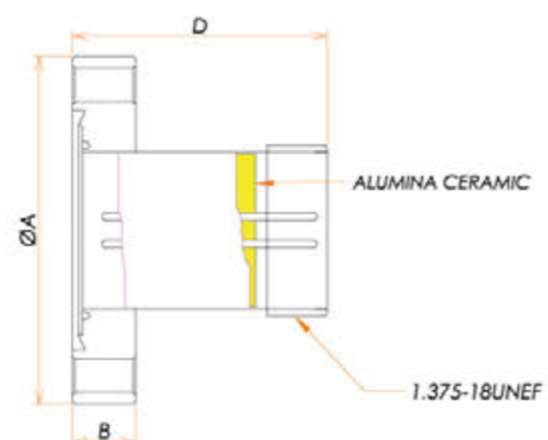

Dimensions in inches (mm)

NW / KF Flange

No. of Pins	INSTALLATION	A	B	D	REFERENCE	PART NUMBER
19	NW / KF 40	2.16 (55)	.24 (6)	2.03 (51.5)	N40MM191	10223

ConFlat® Flange

No. of Pins	INSTALLATION	A	B	D	REFERENCE	PART NUMBER
19	CF 2.75	2.75 (70)	.50 (12.7)	2.01 (51)	C70MM191	10046

Accessories

Description	REFERENCE	PART NUMBER
MS 19 Pin Vacuum Side PEEK® Insulator (250 °C MAX.)	VSP19MS	10222
.062 Socket Contact Vacuum Side	SVC16	10147
MS 19 Pin Air Side Plug	ASP19MS	10008
Removal Tool	PT16	10138
Crimp Tool (AWG #23 to #13)	CT2313	10052

For more details, see Section 6.2



N40MM241 [10126]

Features

MIL-C-5015

The MIL - C - 5015 series is for measurement and control use and is rated to 500 V 3 A, compatible with the MIL - C - 5015 plug. The MS series is offered from 4 pin to 48 pin.

Select flange size and type from NW / KF, ConFlat®, ISO-K, ISO-F and ASA.

Accessories are available, including vacuum side insulators (PEEK®), socket contacts, air side plugs, removal tools, and crimp tools.

We also manufacture custom-made products with quick delivery. Select welding position, number of connectors, and size of custom-made flanges.

Materials

Flange	304 Stainless steel
Shell	Kovar®
Pins	Kovar®
Insulation	Alumina ceramic

Specifications

Type	Multipin MS
MIL-C-5015	24 PIN
Current: A Per Pins	3
Voltage: V max. DC	500
Max. Current all pins loaded	14.4
Insulation: ohm min.	10 ⁹
Frequency: MHz	DC or AC 10 (10 MHz)max.
Leak rate: 1.3×Pa · m ³ /s	10 ⁻¹⁰
Temperature Range: °C*	-196 to 300

*Temperature range will be changed depends on the connection.

NW / KF Flange

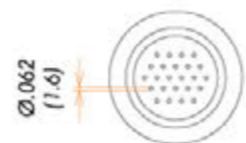
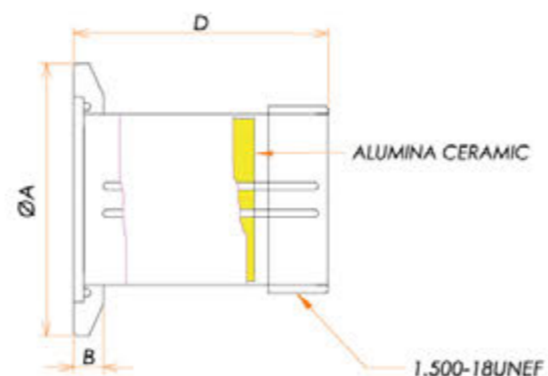

ConFlat® Flange

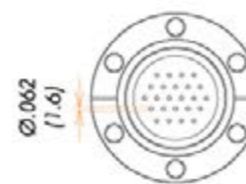
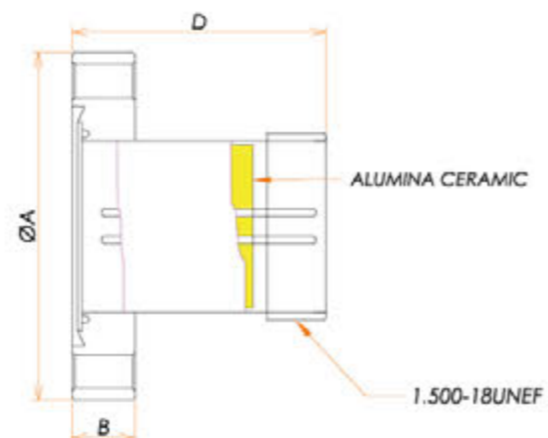

Dimensions in inches (mm)

NW / KF Flange

No. of Pins	INSTALLATION	A	B	D	REFERENCE	PART NUMBER
24	NW / KF 40	2.16 (55)	.24 (6)	2.03 (51.5)	N40MM241	10126

ConFlat® Flange

No. of Pins	INSTALLATION	A	B	D	REFERENCE	PART NUMBER
24	CF 2.75	2.75 (70)	.50 (12.7)	2.01 (51)	C70MM241	10047

Accessories

Description	REFERENCE	PART NUMBER
MS 24 Pin Vacuum Side PEEK® Insulator (250 °C MAX.)	VSPI24MS	10219
.062 Socket Contact Vacuum Side	SVC16	10147
MS 24 Pin Air Side Plug	ASP24MS	10010
Removal Tool	PT16	10138
Crimp Tool (AWG #23 to #13)	CT2313	10052

For more details, see Section 6.2



N40MM371 [10127]

Features

MIL-C-5015

The MIL - C - 5015 series is for measurement and control use and is rated to 500 V 3 A, compatible with the MIL - C - 5015 plug. The MS series is offered from 4 pin to 48 pin.

Select flange size and type from NW / KF, ConFlat®, ISO-K, ISO-F and ASA.

Accessories are available, including vacuum side insulators (PEEK®), socket contacts, air side plugs, removal tools, and crimp tools.

We also manufacture custom-made products with quick delivery. Select welding position, number of connectors, and size of custom-made flanges.

Materials

Flange	304 Stainless steel
Shell	Kovar®
Pins	Kovar®
Insulation	Alumina ceramic

Specifications

Type	Multipin MS
MIL-C-5015	37 PIN
Current: A Per Pins	3
Voltage: V max. DC	500
Max. Current all pins loaded	22.2
Insulation: ohm min.	10 ⁹
Frequency: MHz	DC or AC 10 (10 MHz)max.
Leak rate: 1.3×Pa · m ³ /s	10 ⁻¹⁰
Temperature Range: °C*	-196 to 300

*Temperature range will be changed depends on the connection.

NW / KF Flange

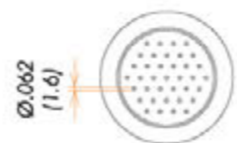
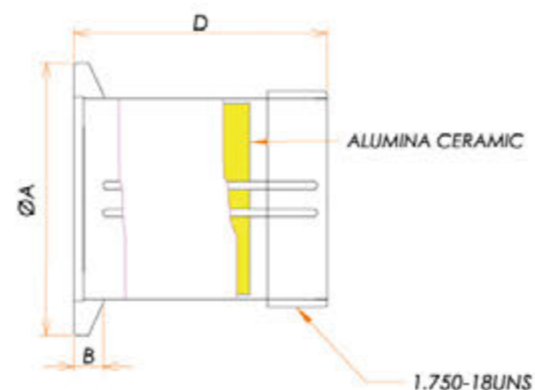

ConFlat® Flange

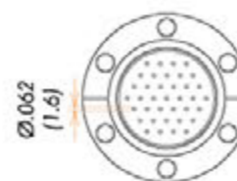
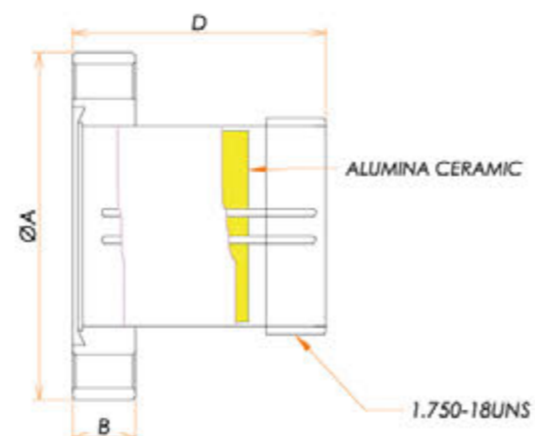

Dimensions in inches (mm)

NW / KF Flange

No. of Pins	INSTALLATION	A	B	D	REFERENCE	PART NUMBER
37	NW / KF 40	2.16 (55)	.24 (6)	2.03 (51.5)	N40MM371	10127

ConFlat® Flange

No. of Pins	INSTALLATION	A	B	D	REFERENCE	PART NUMBER
37	CF 2.75	2.75 (70)	.50 (12.7)	2.01 (51)	C70MM371	10346

Accessories

Description	REFERENCE	PART NUMBER
MS 37 Pin Vacuum Side PEEK® Insulator (250 °C MAX.)	VSPI37MS	10218
.062 Socket Contact Vacuum Side	SVC16	10147
MS 37 Pin Air Side Plug	ASP37MS	10012
Removal Tool	PT16	10138
Crimp Tool (AWG #23 to #13)	CT2313	10052

For more details, see Section 6.2



C70MM141 [10348]

Features

MIL-C-5015

The MIL - C - 5015 series is for measurement and control use and is rated to 500 V 3 A, compatible with the MIL - C - 5015 plug. The MS series is offered from 4 pin to 48 pin. Select flange size and type from NW / KF, ConFlat®, ISO-K, ISO-F and ASA. Accessories are available, including vacuum side insulators (PEEK®), socket contacts, air side plugs, removal tools, and crimp tools. We also manufacture custom-made products with quick delivery. Select welding position, number of connectors, and size of custom-made flanges.

Materials

Flange	304 Stainless steel
Shell	Kovar®
Pins	Kovar®
Insulation	Alumina ceramic

Specifications

Type	Multipin MS
MIL-C-5015	48 PIN
Current: A Per Pins	3
Voltage: V max. DC	500
Max. Current all pins loaded	28.8
Insulation: ohm min.	10 ⁹
Frequency: MHz	DC or AC 10 (10 MHz)max.
Leak rate: 1.3×Pa · m ³ /s	10 ⁻¹⁰
Temperature Range: °C*	-196 to 300

*Temperature range will be changed depends on the connection.

ConFlat® Flange

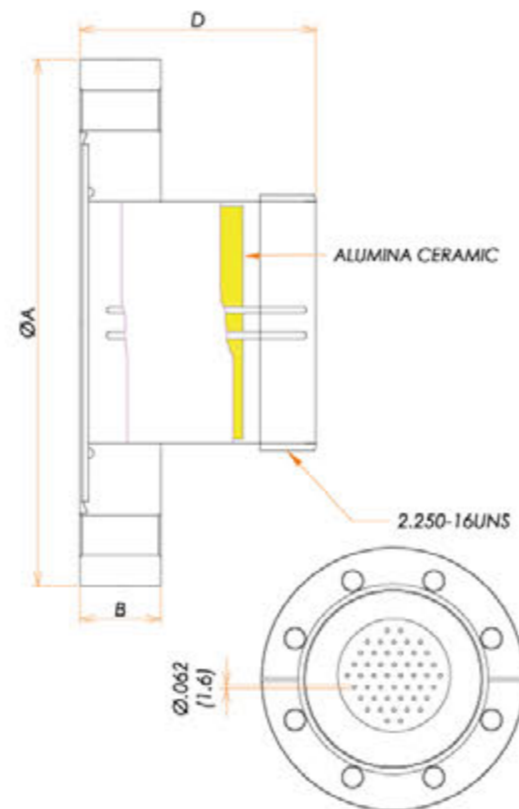

ISO-K Flange

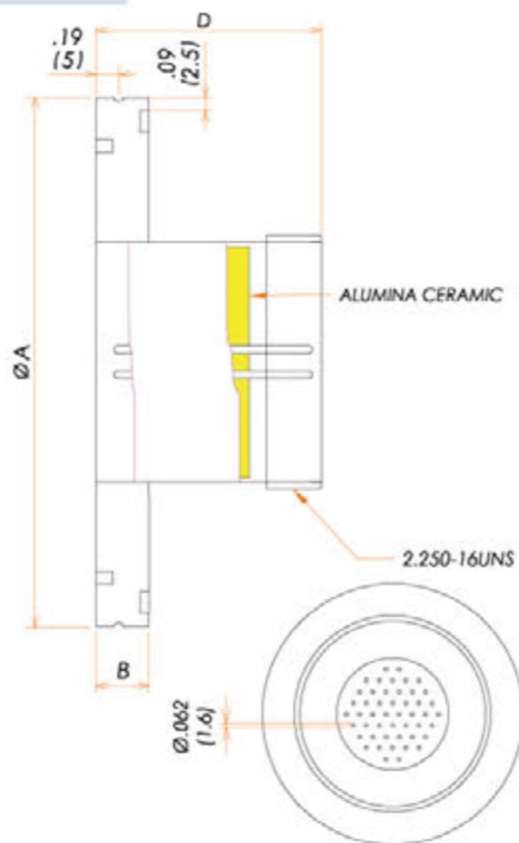

Dimensions in inches (mm)

ConFlat® Flange

No. of Pins	INSTALLATION	A	B	D	REFERENCE	PART NUMBER
48	CF 4.50	4.50 (114)	.69 (17.5)	2.01 (51)	C114MM481	10488

ISO-K Flange

No. of Pins	INSTALLATION	A	B	D	REFERENCE	PART NUMBER
48	ISO-K 63	3.74 (95)	.472 (12)	1.93 (49)	I63MM481	12317

Accessories

Description	REFERENCE	PART NUMBER
MS 48 Pin Vacuum Side PEEK® Insulator (250 °C MAX.)	VSPI48MS	10221
.062 Socket Contact Vacuum Side	SVC16	10147
MS 48 Pin Air Side Plug	ASP48MS	10189
Removal Tool	PT16	10138
Crimp Tool (AWG #23 to #13)	CT2313	10052

For more details, see Section 6.2



C70MD91 [11566]

Features

Subminiature-D

The Subminiature-D series is for measurement and control use and is rated to 300 V 3 A, compatible with MIL-C-24308 plugs. The Subminiature-D series is offered in 9 pin, 15 pin, and 25 pin. We also manufacture the Micro-D series compatible with MIL-DTL-83513 plugs.

Accessories are available, including vacuum side insulating inserts (PEEK®), vacuum side socket contacts, in-vacuum cable assemblies, air side plugs and crimp tools.

We also manufacture custom-made products with quick delivery.

Select welding position, number of connectors, and size of custom-made flanges.

Materials

Flange	304 Stainless steel
Shell	Kovar®
Pins	Kovar®
Insulation	Alumina ceramic

Specifications

Type	MIL-C-24308
Connector	Subminiature-D
Current: A Per Pins	3
Voltage: V max. DC	300
Leak rate: 1.3×Pa · m ³ /s	10 ⁻¹⁰
Temperature Range: °C*	-196 to 300

*Temperature range will be changed depends on the connection.

NW / KF Flange

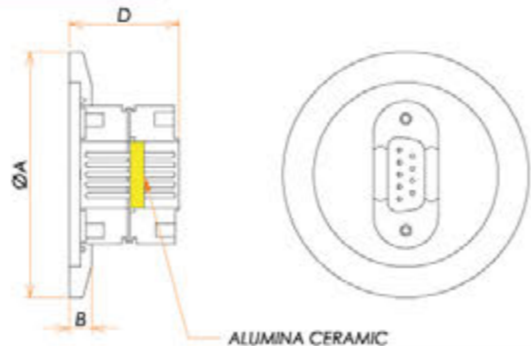

ConFlat® Flange

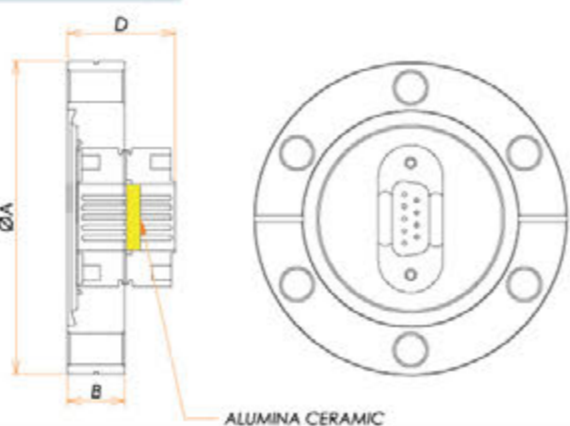

ISO-K Flange

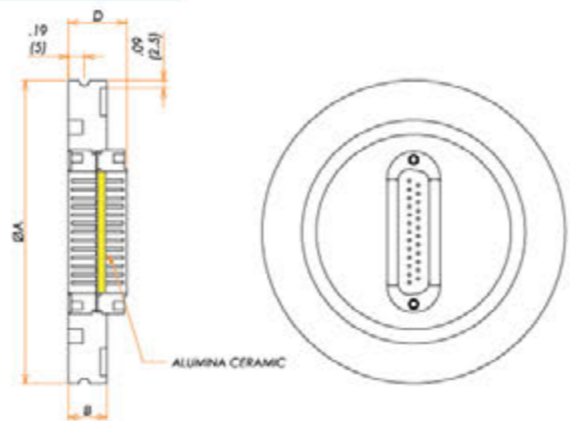

PIN

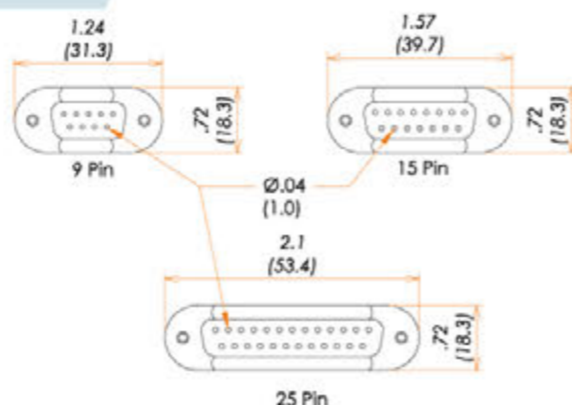

Dimensions in inches (mm)

NW / KF Flange

No. of Pins	INSTALLATION	A	B	D	REFERENCE	PART NUMBER
9	NW / KF 40	2.16 (55)	.24 (6)	.96 (24.5)	N40MD91	11581
15	NW / KF 50	2.96 (75)	.24 (6)	.96 (24.5)	N50MD151	11582

ConFlat® Flange

No. of Pins	INSTALLATION	A	B	D	REFERENCE	PART NUMBER
9	CF 2.75	2.75 (70)	.50 (12.7)	.95 (24)	C70MD91	11566
15	CF 4.50	4.50 (114)	.69 (17.5)	.95 (24)	C114MD151	11567
25	CF 4.50	4.50 (114)	.69 (17.5)	.95 (24)	C114MD251	11568

ISO-K Flange

No. of Pins	INSTALLATION	A	B	D	REFERENCE	PART NUMBER
25	ISO - K 63	3.74 (95)	.472 (12)	.87 (22)	I63MD251	12320

Accessories

Description	REFERENCE	PART NUMBER
Kapton® Cable Assembly with Socket Contacts in Type-D In-Vacuum PEEK® Insulator	VCA500MD9P/X	12161
	VCA1000MD9P/X	12163
	VCA500MD15P/X	12165
	VCA1000MD15P/X	12167
	VCA500MD25P/X	12270
	VCA1000MD25P/X	12271
	VCA500MD9D/X	12169
	VCA1000MD9D/X	12171
	VCA500MD15D/X	12173
	VCA1000MD15D/X	12175
	VCA500MD25D/X	12272
	VCA1000MD25D/X	12273
	ASP9D	11816
	ASP15D	11831
ASP25D	11931	
.04 Socket Contact Vacuum Side	SVC10	10499
Air Side Plug		

For more details, see Section 6.2